

48" Series 7 with Infrared Sear Burner, LPG

Series 7

Stainless Steel | LPG



Taking your grilling experience to the next level, this Series 7 built-in 48" grill provides the ultimate grilling space for premium outdoor kitchens.

- Infrared sear burner for incredibly fast searing up to 24,000 BTU/hr
- Cater for a crowd with the secondary cooking surface
- Build into an outdoor BBQ island, or add a cart for a freestanding grill
- U-burners deliver 25,000 BTU/hr total power per burner with precise heat control from 300°F to 1100°F

DIMENSIONS

Height	24 1/4 "
Width	47 7/8 "
Depth	26 5/8 "

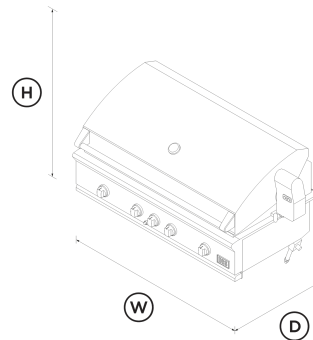

FEATURES & BENEFITS

The Perfect Sear

A dedicated searing zone with a dynamic infrared burner allows you to experience a new level of versatility, using a range of cooking methods. The improved dual rail design offers increased control and faster heating, so you can achieve the perfect sear every time.

Smart Beam™ Grill Light

A halogen light is designed to illuminate the entire cooking surface, ideal for night-time grilling.

Heavy-Duty Infrared Rotisserie

An infrared rotisserie burner provides controlled searing heat up to 18,000BTU. Perfect for entertaining, the heavy-duty motor can easily turn a 50lb load. The rotisserie rod is conveniently stored under the drip pan handle.

Temperature Gauge

Designed for monitoring internal air temperature, the temperature gauge lets you know exactly how hot the grill is - perfect for cooking pizzas or preparing roast meals.

Dual-Sided Grate

One side has a gentle radius for handling delicate foods, such as chicken, fish and vegetables. The other side is W-shaped for perfect sear lines while channeling oil away to an easily removable drip tray.

Extra Cooking Area

Effortlessly cook for a crowd with a secondary cooking space. You can fit a grill pan for slow cooking, roasting and making sauces, or to keep food warm after searing.

Grease Management System™

Our Grease Management System™ reduces flare-ups by channelling grease and oils away from the burner flames during grilling.

SPECIFICATIONS

Accessories (sold separately)

6" accessory storage	ASH6-48
Built-in grill cover	ACBI-48
Griddle plate	BGC-GP

Insulated jacket	BGA48-IJS (optional)
Insulated jacket (with storage accessory unit)	BGA54-IJS (optional)
On cart grill cover	ACC-48
Optional cart mount	CAD1-48

Burners

Number of U-burners	3
Sear burner zone	•

Cooking Surface Area

Primary cooking area	855 sq.in.
Total cooking area	1182 sq.in.
Warming rack area	327 sq.in.

Features

Double sided Stainless Steel grilling grates	•
Full surface searing	•
Grease management system™	•
Hood temperature gauge	•
Ignition system	Spark
Metal dials	•
Rotisserie	•
Warming rack	•
Wireless temperature sensor compatible	•

Finish

Material **304 grade stainless steel**

Weather resistant **•**

Gas Requirements

1/2" NPT male with 3/8" in flare adapter	•
Gas type	LPG
LP hose with regulator and Type 1 connector	•
Operational pressure	11" W.C.
Supply pressure	12" to 14" W.C.

Installation Dimensions

Cutout depth (proud)	22 3/4 "
Cutout height (proud)	10 1/8 "
Cutout width (proud)	45 3/4 "
Insulated jacket for proud cut-out	Varies - check manual

Performance

Rotisserie burner power	18000 BTU
Sear burner power	24000 BTU
Total Power	117000 BTU
U-burner power	25000 BTU
Weight rotisserie can handle	50 lbs

Power Requirements

Grill power supply	9V Battery for Ignition
Rotisserie power supply	120V 60Hz













Product Dimensions

Packaged weight	348 lbs
Width including rotisserie	56 3/8 "

SKU **71596**

The product dimensions and specifications in this page apply to the specific product and model. Under our policy of continuous improvement, these dimensions and specifications may change at any time. You should therefore check with Fisher & Paykel's Customer Care Centre to ensure this page correctly describes the model currently available. © DCS by Fisher & Paykel Appliances Limited 2020

Other product downloads available at [dcsappliances.com](https://www.dcsappliances.com)

-  Data Sheet Grill
-  Data Sheet Grill with ASH648 Storage Unit
-  Data Sheet Grill with BGA48-IJS Insulated Jacket
-  Installation Guide Grill EN
-  Guide d'installation FR
-  Guía de instalación SP
-  Planning Guide EN - Professional Grills Series 7 Outdoor Kitchen
-  Planning Guide FR - Professional Grills Series 7 Outdoor Kitchen
-  Planning Guide SP - Professional Grills Series 7 Outdoor Kitchen
-  Service and Warranty
-  User Guide Grill EN
-  Guide d'utilisation FR
-  Guía del usuario SP

A PEACE OF MIND SALE

24 Hours 7 Days a Week Customer Support

T 1.888.936.7872 W www.dcsappliances.com