

36" Series 9 with Infrared Sear Burner, LPG

Series 9

Stainless Steel | LPG



This Series 9 built-in 36" grill is designed for premium outdoor kitchens and will take your outdoor cooking experience to the next level.

- Infrared sear burner for incredibly fast searing up to 24,000 BTU/hr
- Cater for a crowd with the secondary cooking surface
- Build into an outdoor BBQ island, or add a cart for a freestanding grill
- U-burners deliver 25,000 BTU/hr total power per burner with precise heat control from 300°F to 1100°F

DIMENSIONS

Height	27 1/4 "
Width	35 15/16 "
Depth	26 7/8 "

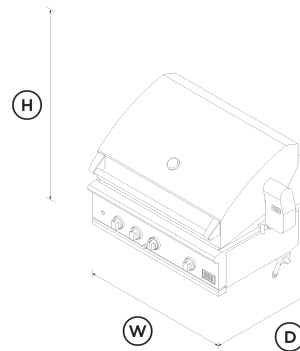

FEATURES & BENEFITS

The Perfect Sear

A dedicated searing zone with a dynamic infrared burner allows you to experience a new level of versatility, using a range of cooking methods. The improved dual rail design offers increased control and faster heating, so you can achieve the perfect sear every time.

Charcoal Smoker Tray

Enjoy a smoky barbecue flavour with the ease of instant gas flame ignition. Grill directly on the cooking grate or add wood chips for extra smoke. A W-shaped tray with adjustable vents helps the charcoal last longer.

Heavy-Duty Infrared Rotisserie

An infrared rotisserie burner provides controlled searing heat up to 14,000BTU. Perfect for entertaining, the heavy-duty motor can easily turn a 50lb load. The rotisserie rod is conveniently stored under the drip pan handle.

Intuitive Lighting

Brilliant 12-volt lighting safely illuminates the entire grilling surface when you open the lid. Ideal for night-time cooking, the bezel dial lighting glows white when the grill is on, and orange when the gas and grill are in use.

Easy Lifting Hood

The hood can be opened using one hand for better access and visibility when cooking. You can easily accommodate larger food loads with extra space under the hood.

Extra Cooking Area

Effortlessly cook for a crowd with a secondary cooking space. You can fit a grill pan for slow cooking, roasting and making sauces, or to keep food warm after searing.

Grease Management System™

Our Grease Management System™ reduces flare-ups by channelling grease and oils away from the burner flames during grilling.

SPECIFICATIONS

Accessories (sold separately)

6" accessory storage	ASE6-36
Built-in grill cover	ACBI-36E

Griddle plate	BGC-GP
Insulated jacket	BGA36-IJS (optional)
Insulated jacket (with storage accessory unit)	BGA42-IJS (optional)
On cart grill cover	ACC-36E
Optional cart mount	CAD-36E

Burners

Number of U-burners	2
Sear burner zone	•

Cooking Surface Area

Primary cooking area	630 sq.in.
Secondary cooking area	534 sq.in.
Total cooking area	1164 sq.in.

Features

Double sided grilling grates	flat and angled position
Full charcoal burner/smoker	•
Full surface searing	•
Grease management system™	•
Hood temperature gauge	•
Ignition system	Hot surface
Metal dials	•
Rotisserie	•
Secondary cooking	2-level racks and tray
Wireless temperature sensor compatible	•

Finish	
Material	304 grade stainless steel
Weather resistant	•

Gas Requirements

1/2" NPT male	•
Gas type	LPG
LP hose with regulator and Type 1 connector	•
Operational pressure	11" W.C.
Supply pressure	12" to 14" W.C.

Installation Dimensions

Cutout depth (proud)	22 3/4 "
Cutout height (proud)	10 1/8 "
Cutout width (proud)	34 1/2 "
Insulated jacket for proud cut-out	Varies - check manual

Performance

Rotisserie burner power	14000 BTU
Sear burner power	24000 BTU
Total Power	88000 BTU
U-burner power	25000 BTU
Weight rotisserie can handle	50 lbs

Power Requirements

















Rotisserie power supply	120V 60Hz
-------------------------	------------------

Supply frequency	60 Hz
Supply voltage	120 V

SKU	71594
-----	--------------

The product dimensions and specifications in this page apply to the specific product and model. Under our policy of continuous improvement, these dimensions and specifications may change at any time. You should therefore check with Fisher & Paykel's Customer Care Centre to ensure this page correctly describes the model currently available. © DCS by Fisher & Paykel Appliances Limited 2020

Other product downloads available at dcsappliances.com

-  2D-DWG Grill
-  2D-DWG Grill with Storage Unit
-  2D-DWG Grill with Storage Unit and Insulated Jacket
-  2D-DWG Grill with Insulated Jacket
-  2D-DXF Grill
-  2D-DXF Grill with Storage Unit
-  2D-DXF Grill with Storage Unit and Insulated Jacket
-  2D-DXF Grill with Insulated Jacket
-  Data Sheet Grill with ASE636 Storage Unit
-  Data Sheet Grill with BGA36-IJS Insulated Jacket
-  Installation Guide Grill EN
-  Installation Guide Grill on Cart EN
-  Guide d'installation FR
-  Installation Guide Grill on Cart FR
-  Guía de instalación SP
-  Installation Guide Grill on Cart SP
-  Planning Guide EN - Professional Grills Series 9 Outdoor Kitchen

- ↓ [Planning Guide FR - Professional Grills Series 9 Outdoor Kitchen](#)
- ↓ [Planning Guide SP - Professional Grills Series 9 Outdoor Kitchen](#)
- ↓ [Revit-18 Grill](#)
- ↓ [Revit-18 Grill with Storage Unit](#)
- ↓ [Rhino-5 Grill](#)
- ↓ [Rhino-5 Grill with Storage Unit](#)
- ↓ [Rhino-5 Grill with Storage Unit and Insulated Jacket](#)
- ↓ [Rhino-5 Grill with Insulated Jacket](#)
- ↓ [Service and Warranty](#)
- ↓ [Sketchup-8 Grill](#)
- ↓ [Sketchup-8 Grill with Storage Unit](#)
- ↓ [Sketchup-8 Grill with Storage Unit and Insulated Jacket](#)
- ↓ [Sketchup-8 Grill with Insulated Jacket](#)
- ↓ [User Guide Grill EN](#)
- ↓ [Guide d'utilisation FR](#)
- ↓ [Guía del usuario SP](#)

A PEACE OF MIND SALE

24 Hours 7 Days a Week Customer Support

T 1.888.936.7872 W www.dcsappliances.com